

Fixture #

SPECIFICATIONS:

Single bowl drop-in sink with ledge, off the bowl clamp system, self rimming, foam rim gasket installed, exposed surfaces finished to a satin finish, sound deadening pads. Includes template and installation hardware.

OVERALL DIMENSIONS:

Left to Right: 16" (41cm)
Front to Back: 20 1/2" (52cm)

BOWL DIMENSIONS:

Left to Right: 14" (36cm)
Front to Back: 16" (41cm)
Bowl depth: 5" (13cm)

MATERIAL:

20 gauge, 18-8 stainless steel
301 Series

WASTE:

3 1/2" basket strainer assembly with tailpiece included
Location: Center Rear

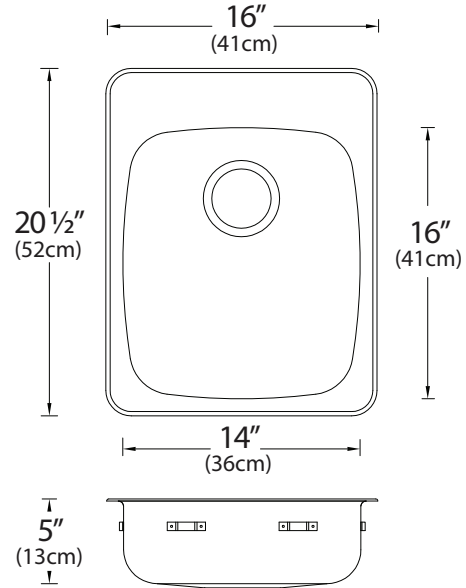

PROJECT INFORMATION:

Item Location: _____
 Project Number: _____
 Project Name: _____
 Quote Number: _____
 Faucet Model: _____
 Notes: _____

HOLE DRILLINGS			1 0	2 4
Hole Configuration	# to enter above	Check hole selection		
1 hole	1 0	<input type="checkbox"/>		
3 hole, 8" (20cm) centre	3 8	<input type="checkbox"/>		
† 2 hole, 4" (10cm) centre	2 4	<input type="checkbox"/>		
† 3 hole, 4" (10cm) centre	3 4	<input type="checkbox"/>		
† 4 hole, 8" (20cm) centre	4 R	<input type="checkbox"/>		
† Special Holes (drawing must be included)	S H	<input type="checkbox"/>		

† Indicates custom product and is Non-returnable
 All holes are 1 1/2" diameter.

Engineer's Approval

Novanni has a policy of continuous improvement.
 All product specifications may change without notice.